

# Data Sheet



Article number: 339706440000

Description: Multibeam 6 Coupling 706.44.0000  
Aluminium relieved & set screw hubs

## Measures

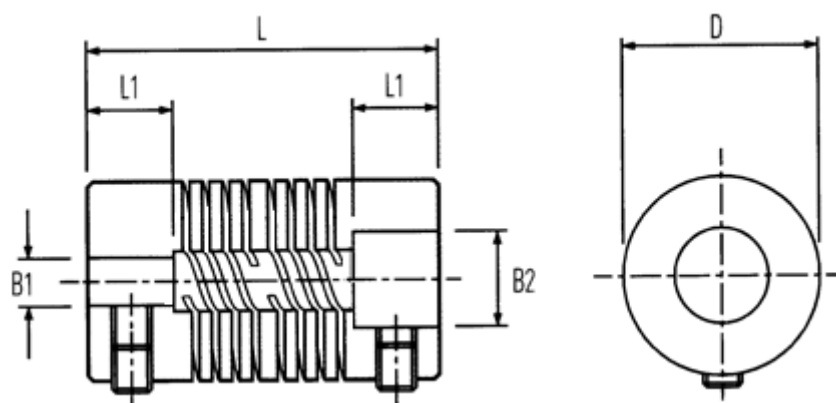

B1: Pre-drilled	= 9.0
B2: Pre-drilled	= 14.00
D	= 44.5
L	= 76.2
L1	= 20.0
Max angular displacement	= 0.80
Max B1 & B2	= 25.00
Max parallel displacement	= 7

Peak Torque NM	= 30.00
Set Screw	= M6